

Find the measure of the arc or angle indicated. Assume that lines which appear tangent are tangent.

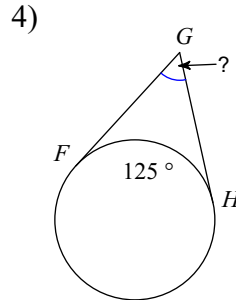

Solve for  $x$ . Assume that lines which appear tangent are tangent.

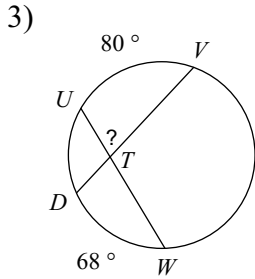
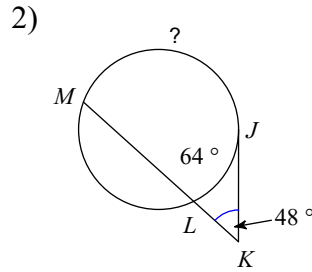
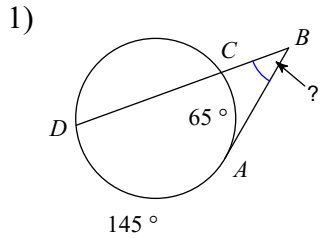
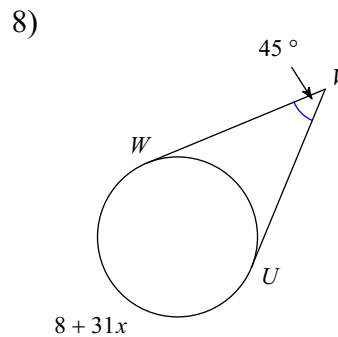
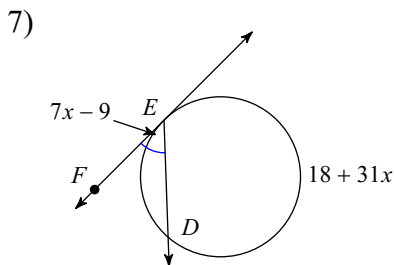
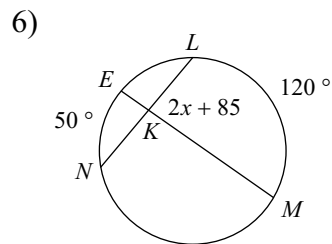
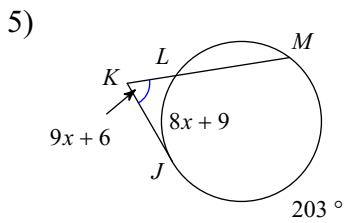

Find the measure of the arc or angle indicated. Assume that lines which appear tangent are tangent.

9)  $m\widehat{KNM} = 2x + 230$   
Find  $m\widehat{KNM}$

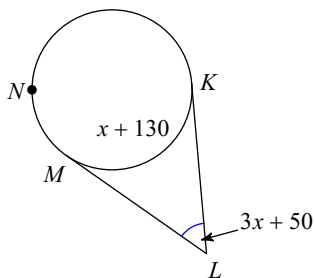

10) Find  $m\widehat{KL}$

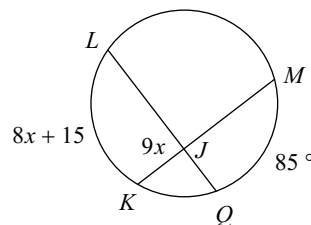

11) Find  $m\widehat{CG}$

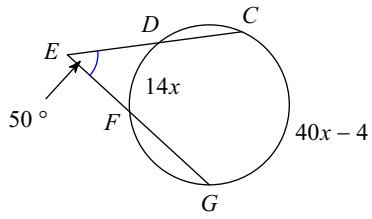

12) Find  $m\angle JKM$

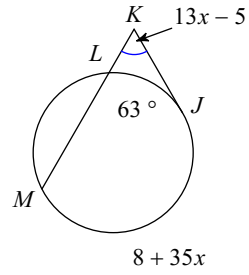

13)

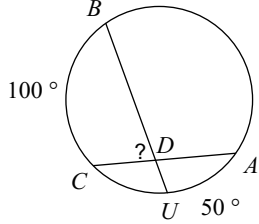

14)

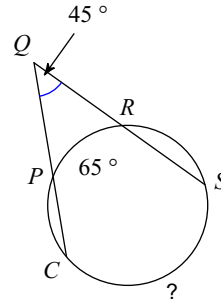

15)

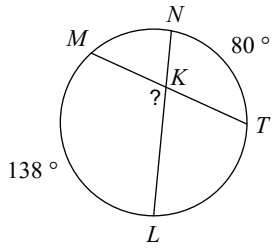

16)

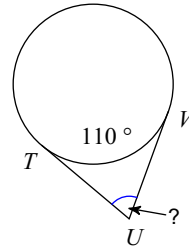

**Find the measure of the arc or angle indicated.**

17)

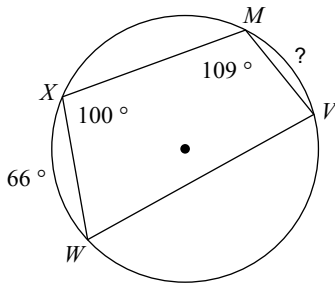

18)

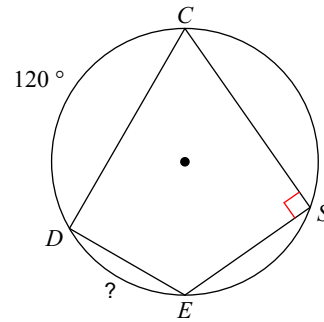

19)

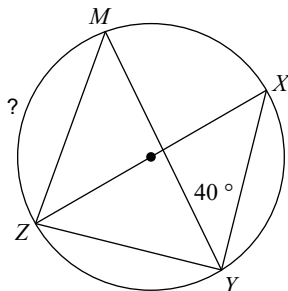

20)

